

MIT Arts, Commerce and Science College,  
Alandi (D), Pune – 412 105.



**6.3.2 Average percentage of teachers provided with financial support to attend conferences/workshops and towards membership fee of professional bodies during the last five years**

6.3.2.1. Number of teachers provided with financial support to attend conferences/workshops and towards membership fee of professional bodies year wise during the last five years

(AY 2014-15 to 2018-19)

# INDEX

<b>Sr. No.</b>	<b>Particulars</b>	<b>Page No.</b>
01	Policy document on providing financial support to teachers	3
02	List of teachers receiving financial support (2014-15)	6
03	E-copy of letter/s indicating financial assistance (2014-15)	8
04	Audited Statement (2014-15)	10
05	Certificates (2014-15)	11
06	List of teachers receiving financial support (2015-16)	21
07	E-copy of letter/s indicating financial assistance (2015-16)	23
08	Audited Statement (2015-16)	27
09	Certificates (2015-16)	28
10	List of teachers receiving financial support (2016-17)	41
11	E-copy of letter/s indicating financial assistance (2016-17)	43
12	Audited Statement (2016-17)	46
13	Certificates (2016-17)	47
14	List of teachers receiving financial support (2017-18)	59
15	E-copy of letter/s indicating financial assistance (2017-18)	61
16	Audited Statement (2017-18)	62
17	Certificates (2017-18)	63
18	List of teachers receiving financial support (2018-19)	67
19	E-copy of letter/s indicating financial assistance (2018-19)	69
20	Audited Statement (2018-19)	72
21	Certificates (2018-19)	73

---

# Training And Development Policy

---

Training needs to be given to enable the staff to perform their professional functions more effectively. They are motivated and learn to take initiative, personal responsibility, cooperate and work in team at all levels. It is a human resource development process, resulting in change of behavior and developing or refining Institutional systems and procedures that will support an individual's efforts while working.

Identification of training areas will be done by the immediate superior (HOD) and as per the requirements, the HOD will arrange training programmes with the help of HR Department. Suggestions from the staff may also be invited regarding the areas in which they feel training is required.

All newly joined faculty members will have to undergo faculty orientation programme to understand the philosophy and functioning of the Institution. The duration of the programme may vary as per needs.

As far as possible, the basic training sessions will be organized in-house like ISO 9001:2008 awareness, health awareness etc. Employees will also be encouraged to go for trainings sponsored by ISTE, SPPU, DTE, UGC, AICTE, IITs etc.

However, the Institution encourages its entire staff to undergo QIPs and to attend other trainings & seminars as part of faculty development program. Each department at the beginning of an academic year will be made aware of the budget allocated for that year to meet such expenses.

Heads of departments / sections shall ensure that every employee gets an even opportunity to undergo faculty development programmes.

A record of trainings will be kept by HR for all employees in their personal files. The Institution will encourage and support the training and development of all its staff members and is dedicated to promoting a vibrant team of employees.

### **SEMINARS AND WORKSHOPS:**

- i. For attending seminars and workshops, approval from the head of Institution is required.
- ii. For tours, prior approval from the head of Institution is required.
- iii. For tours within the country, registration fee can be paid by the Institution and TA/DA rules remain the same.
- iv. For tours outside India, prior permission regarding the travel and travel expenses ought to be taken.

### **HIGHER STUDIES :**

1. Faculty members are also encouraged to take up higher education.
2. Every year one permanent faculty member from each program may be permitted to go on paid leave For a period of not more than one semester to pursue Ph.D.
3. Ph.D. has to be pursued only in the IISC or any of the IITs (or from any reputed Institution or University). Various modes of admission to these Institutions are available, wherein a Ph.D. student has to spend only one semester at the place of research.
4. Candidates selected through the Quality Improvement Program (QIP) may be relieved for a period of 3 years during which they may be entitled for half pay. Ph.D. has to be completed in the period of 3 years.
5. Candidates sponsored by the Institution will have to serve the Institution for a minimum period of 6 years after the completion of their Ph.D. and shall have to execute a bond supported by a bank guarantee accordingly.
6. Candidates desirous of pursuing post doctoral research (PDR) in India or abroad may be relieved of their duties for the duration of the project they are selected for. This duration however is subject to a maximum of 2 years. (Institution may adequately compensate for the loss of pay, if any, caused due to pursuing of PDR.)

## **Application Process**

### **Objective**

Training needs to be given to enable to faculty members/staff to perform their professional functions effectively as well as achieve improved motivation, initiative, personal responsibility, cooperation and team work among the staff at all levels. It is a human development process, resulting in a change of behavior; and developing or refining Institutional systems and procedures that will support individual efforts while working.

### **Eligibility**

Identification of training areas will be done by the immediate superior (HOD) and as per the requirements the HOD will arrange the training programs with the help of HR Department. Suggestions from the staff may also be invited regarding the areas in which they feel training is required. Faculty/staff members are also encouraged to take up higher education.

Every year one permanent faculty member who has completed minimum 2 years with the Institution from each program may be permitted to go on study leave for a period of not more than three years to pursue higher studies in India or Abroad.

**Process :**

The Institution may compensate half gross pay of the Faculty member for the approved period.

The faculty member will have to give an application to the management with the details of program attached for approval at least 2 months in advance. Whether or not to approve such leave is management's discretion.

If the study leave is sanctioned and the management is compensating half gross pay, the faculty member will have to sign an agreement (bond) – **Annexure XVIII** with the Institution for a period of minimum 2 years or more.

If the faculty member fails to abide by the agreement he/she will have to repay the compensated amount with penalty as mentioned in the agreement. If he/she fails to complete the program in stipulated time the Institution will stop paying him/her the half salary for the extended period and whether to sanction the extended leave or not will be at the discretion of the management. (If he/she fails to complete the program still will have to pay penalty amount.)

The penalty amount would be calculated @ 18% interest per annum on the total half salary paid to the faculty member.

**Annexure XVIII : Agreement Bond**

# **MIT | Arts, Commerce & Science College**

**Maharashtra Academy of Engineering and  
Educational Research's**

**MIT Arts, Commerce and Science College,**

**Alandi (D) – 412 105.**

**< FINANCIAL SUPPORT FOR TEACHERS TO  
ATTEND CONFERENCE / WORKSHOP >**

**< A.Y. 2014-15 >**

## List of teachers receiving financial support (2014-15)

Sr. No.	Name of teacher	Name of conference/ workshop attended for which financial support provided	Name of the professional body for which membership fee is provided	Amount of support
1	Prof. Sunil Mahajan	Workshop on Implementation of SY B.Sc. (CS) Electronics Syllabus	University of Pune	550
2	Prof. Vikas Mahandule	Workshop on Restructing of SYBCA & SYMCA Practical Slips	Dr. D. Y. Patil ACS College & DRDC, University of Pune	400
3	Prof. Akshada Kulkarni	Workshop on Restructing of SYBCA & SYMCA Practical Slips	Dr. D. Y. Patil ACS College & DRDC, University of Pune	800
4	Prof. Amit Tale	Workshop on Restructing of TYBCA & TYMCA Practical Slips	Dr. D. Y. Patil ACS College & DRDC, University of Pune	1400
5	Prof. Pradip Pansare	State Level Workshop on "Numerical Techniques using Scilab and OR Problem verification by TORA"	MAEER's ACSC, Pune	1100
6	Prof. Mangesh Bhople	Workshop on National Skills & Qualification Framework Engineering	organized by AICTE at Govt Engineering College, Awasari	393
7	Prof. Sunil Mahajan	National Conference on Advance & Challenges in Green Technology"	Sinhagad College, Pune	1100
8	Prof. S. N. Kargaonkar	National Conference on "CSR: Relation between Business & Society "	SKN Sinhadgad School of Management, Pune	1400
9	Prof. S. N. Kargaonkar	National Conference on " Impact of ICT in Education of Arts, Commerce & Science"	Poona College	1700
10	Prof. Sunil Mahajan	International Conference on "Nano Science & Nano Technology"	SRM University Chennai	12263

**802 - (14-15) MIT ACSC**  
**Staff Training & Staff Welfare**  
 Ledger Account

1-Feb-2014 to 31-Mar-2015

Page 1  
Credit

Date	Particulars	Vch Type	Vch No.	Debit
23-7-2014	To <b>Cash</b> <i>being cash paid for registration fees &amp; Conveyance allowance for workshop on view "implementation of Sy BCS - CS electronic syllabus" organized by unviersity of pune dt 27.06.2014 with details attached ( Sunil Mahajan)</i>	Payment	248	550.00
11-2-2015	To <b>UBI Current 446401011022015 - Payment A/c</b> <i>Ch. No. .006625 Being Payment against Registration Fees for conference organized by SRM UNI Cherinai &amp; Travelling allowance return back dt 04.02.2015 to 06.02.2015 as per details attached - Sunil P Mahajan</i>	Payment	006625	12,263.00
16-2-2015	To <b>Cash</b> <i>being cash paid for registration fees &amp; conveyance allowance for 2 days National conference organized by poons college as per details attached - Shriram Kargaonkar</i>	Payment	642	1,700.00
17-2-2015	To <b>Cash</b> <i>being cash paid for registration fees for national level FDP &amp; workshop for ACS college D Y Patil as per details attached - Vikas Mahandule</i>	Payment	644	400.00
	To <b>Cash</b> <i>being cash paid for registration fees for national level FDP &amp; workshop for ACS College DY Patil as per details attached - Akshada Kulkarni</i>	Payment	645	800.00
	To <b>Cash</b> <i>being cash paid for registration fees for national level FDP &amp; workshop for ACS College DY Patil as per details attached - Amit Tale</i>	Payment	646	1,400.00
	To <b>Cash</b> <i>being cash paid for registration fees &amp; conveyance allowance for workshop dt 28.11.2014 &amp; 29.11.2014 as per details attached - Pradip Pansare</i>	Payment	647	1,100.00
26-2-2015	To <b>Cash</b> <i>being cash paid for one day workshop national skills qualifacaton framework engineering dt 22.09.2014 to Awasari - Pune as per details attached - Mangesh bhople</i>	Payment	676	393.00

Carried Over

18,606.00

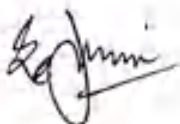

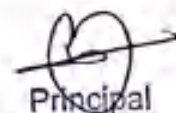

continued ...

Principal  
 MIT Arts, Commerce & Science College  
 Alandi, Pune - 412 105.



802 - (14-15) MIT ACSC

Staff Training & Staff Welfare Ledger Account : 1-Feb-2014 to 31-Mar-2015

Date	Particulars	Vch Type	Vch No.	Debit	
	Brought Forward			18,606.00	
28-2-2015	To Cash <i>being cash paid for registration fees &amp; conveyance allowance fro 2 days National conference organized by sinhgad college pune as per details attached. - Sunil Mahajan BCS dept</i>	Payment	685	1,100.00	
2-3-2015	To Cash <i>being cash paid for registration fees &amp; Conveyance allowance for 2 days national conference organized by S K N Sinhgad School, Pune as per details attached. - Shriram Kargaonkar</i>	Payment	687	1,400.00	
				21,106.00	
By	Closing Balance			21,106.00	21,106.00
				21,106.00	21,106.00



Principal  
MIT Arts, Commerce & Science College  
Alandi, Pune - 412 105.

# Audit Statements for F.Y. - 2014-15

10	Consumable goods	28,000.00
11	Conveyance expenses	87,923.00
12	CPI admin charges	105,263.00
13	Electricity Charges	821,238.00
14	Exam expenses	-17,007.00
15	Gathering expenses	84,100.00
16	Industrial visits	11,905.00
17	Interest on equipment loan	21,987.00
18	M Pluse event	34,999.00
19	Office Expenses	323,349.00
20	Placement activities	54,019.00
21	Postage and courier	15,098.00
22	Printing and stationery	633,818.00
23	Professional fees	222,700.00
24	Repairs and maintenance	158,602.00
25	Seminar & Conference	3,660.00
26	Sports and other activities	93,865.00
27	Staff training and welfare	70,026.00
28	Telephone and internet charges	24,184.00
29	Travelling expenses	2,026.00
30	University fees	222,739.00
<b>TOTAL RS.</b>		<b>41,073,256.10</b>

## SCHEDULE NO. 11

### INCOME FROM OTHER SOURCES

SR. NO.	PARTICULARS	AMOUNT RS	AMOUNT RS
1	Fees College		
a	B Com		
b	B Sc Computer	4,651,100.00	
c	BA	21,572,900.00	
d	BBA	436,200.00	
e	BBM	6,301,600.00	
f	BCA	882,100.00	
g	M Sc Computer	7,952,500.00	
h	MCA	6,469,400.00	
		<u>4,276,300.00</u>	
		52,542,300.00	
	Less : concessions granted	<u>137,600.00</u>	52,404,700.00





"The Woman-Soul will lead us upward, on!" - Sadhu Vaswani

# St. Mira's College For Girls, Pune

## Certificate of Participation

*This certificate is awarded to*

Mr. Sunil Mahajan

for participating in the workshop on "Implementation of SYBSc(C.S)  
Electronics Syllabus"

held on 27/6/14

*S. Anbar*

Vice-Principal

St. Mira's College For Girls

*H. J. Jindani*

Principal



Dr D.Y. Patil Vidya Pratishthan Society's  
**DR. D.Y. PATIL ARTS, COMMERCE AND SCIENCE COLLEGE**  
Pimpri , Pune -18  
(NAAC Accredited B++ Grade)



&  
**DEPARTMENT OF COMMERCE SAVITRIBAI PHULE PUNE UNIVERSITY,**  
ORGANIZES  
**ONE DAY WORKSHOP ON**  
"Restructuring of Third Year B.C.A. and M.C.A. (Commerce) Practical Slips"

## *Certificate*

This is to certify that Prof/Dr/Mr/Mrs/Miss Nikas Mahandule  
of M.I.T A.C.S.C College, Alandi College / Institute has participated in  
*One Day Workshop* on "Restructuring of Third year B.C.A. and M.C.A. (Commerce) Practical Slips"  
conducted on 30<sup>th</sup> July 2015 at Dr. D. Y. Patil Arts, Commerce and Science College Pimpri, Pune - 18.

**Dr. Ranjit Patil**  
Vice Principal & Co-ordinator

**Dr. Snehal Agnihotri**  
Principal

**Dr. Sanjay Kaptan**  
Professor & Head  
Department of Commerce, SPPU.



Dr. D. Y. Patil Vidya Pratishthan Society  
PADMASHREE DR. D.Y. PATIL ARTS, COMMERCE AND SCIENCE COLLEGE  
Pimpri, Pune -18  
(NAAC Accredited B++ Grade)



&  
DEPARTMENT OF COMMERCE AND RESEARCH CENTRE,  
UNIVERSITY OF PUNE (DCRC)

ORGANIZES

ONE DAY WORKSHOP ON

"Restructuring of S.Y.B.C.A. and Second Year M.C.A. (Commerce) Practical Slips"

## Certificate

This is to certify that Prof/Dr/Mr/Mrs/Miss Ashada Kulkarni  
A.C.S.C. Mandi College/ Institute has participated in  
*One Day Workshop* on "Restructuring of S.Y.B.C.A. and Second Year M.C.A. (Commerce) Practical Slips"  
conducted on 24<sup>th</sup> July 2014 at Department of Commerce and Research Centre, University of Pune.

  
Dr. Ranjit Patil  
Coordinator & Co-ordinator

  
Dr. Snehal Agnihotri  
Principal

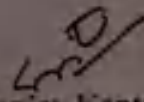
  
Dr. Sanjay Kaptan  
Professor & Head DCRC



Dr D.Y. Patil Vidya Pratishthan Society's  
**PADMASHREE DR. D.Y. PATIL ARTS, COMMERCE AND SCIENCE COLLEGE**  
Pimpri, Pune -18  
(NAAC Accredited B++ Grade)

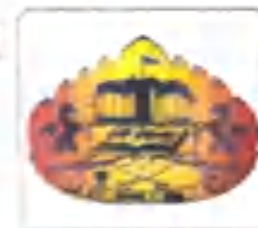

&  
**DEPARTMENT OF COMMERCE AND RESEARCH CENTRE, (DCRC)**  
**SAVITRIBAI PHULE PUNE UNIVERSITY**  
ORGANIZES

**ONE DAY WORKSHOP ON**

“Restructuring of T.Y.B.C.A and Third Year M.C.A. (Commerce) Syllabus & Practical Slips”

## *Certificate*

This is to certify that Prof/Dr/Mrs/Miss Amit . V. Tale  
of M. I. I. A. C. S College, Alandi College / Institute has participated in  
*One Day Workshop* on “Restructuring of T.Y.B.C.A and Third Year M.C.A (Commerce) Syllabus &  
Practical Slips” conducted on 23<sup>rd</sup> Dec 2014 at Department of Commerce and Research Centre (DCRC),  
Savitribai Phule Pune University.

**Ranjit Patil**  
Principal & Co-ordinator

**Dr Snehal Agnihotri**  
Principal

**Dr Sanjay Kaptan**  
Professor & Head DCRC



MAEER's  
ARTS, COMMERCE & SCIENCE COLLEGE PUNE INDIA

ESTD.: 2004



University of Pune

(Accredited by NAAC with 'A' Grade)

State Level Workshop

on

Numerical Techniques using Scilab and OR Problem Verification by TORA  
Under the Quality Improvement Program of  
Savitribai Phule Pune University

## Certificate

This is to certify that, Prof/Dr./Mr./Ms./Mrs. Pradip Pansare of  
MAEER's Arts, Comm & Sci college has attended Two Days State Level Workshop on  
"Numerical Techniques using Scilab and OR Problem Verification by TORA" organized by the Department of  
Mathematics & Statistics, MAEER's Arts, Commerce & Science College, Pune, on 28<sup>th</sup> & 29<sup>th</sup> November, 2014.

**S. G. Ranade**  
Suvarna Ranade  
Convener  
Head, Dept. of Mathematics & Statistics,

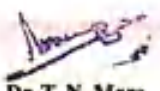
  
**Dr. T. N. More**  
Principal, MAEER's Arts, Commerce  
& Science College, Pune,

  
**Rahul V. Karad**  
Vice President, Executive Director  
MAEER's MIT Group of Institutions, Pune

MACS College - One Decade of Academic Excellence

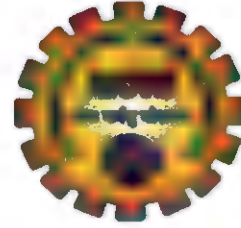

# Government College of Engineering and Research, Awasari (Kh),

Tal. Ambegaon, Dist. Pune.

Date-22/09/14

## CERTIFICATE

This is to certify that Mr. Mangesh M. Bhople. of  
(Institute/Organization) MIT, ACSC, Alandi, pune. has attended a  
workshop on “**National Skills Qualifications Framework (NSQF)**” under the  
auspices of All India Council for Technical Education (AICTE), New Delhi, organized  
by Government College of Engineering and Research, Awasari (Kh).

**Prof. S. V. Joshi**  
Principal & Coordinator





Sinhgad Institutes

Sinhgad Technical Education Society's

# SINHGAD COLLEGE OF SCIENCE



Savitribai Phule Pune University

National Conference on

## "Advances and Challenges in Green Technology"

### Certificate

This is to certify that Mr. /Ms./Dr. /Prof. Sunil Mahajan of M.T.T College, Alandi has participated/presented (oral/poster presentation) entitled Smart traffic signal to reduce Pollution and fuel wastage due to idling of vehicles at intersection in National Conference on "Advances and Challenges in Green Technology" held at Sinhgad College of Science, Ambegaon (Bk.), Pune- 41 under Quality Improvement Program, Savitribai Phule Pune University on 13<sup>th</sup> - 14<sup>th</sup> February 2015.

*Sheelavantmath*  
 Dr. Suman S. Sheelavantmath  
 Organizing Secretary

*DR*  
 Dr. Deepa Ramane  
 Co-Convenor

*Magan P. Ghatule*  
 Dr. Magan P. Ghatule  
 Convenor & Principal



Sinhgad Technical Education Society's  
S.K.N. Sinhgad School of Business Management

(Approved by AICTE & Affiliated to Savitribai Phule Pune University)  
S. No. 10/1, Ambegaon (Bk.), Pune-411 004

And



Savitribai Phule Pune University

Under Quality Improvement Programme

CONFLUENCE 2015

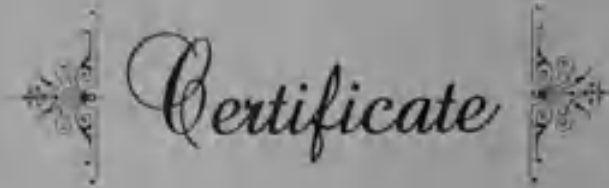

This is to certify that

*Dr. N. N. Shrivastava N. Kargankar*

of *MIT Arts, Commerce & Science College, Alandi, Pune*

has participated in the National Research Conference on

**"CSR: Relation Between Business and Society"** held on

13-14 February 2015 at S.K.N. Sinhgad School of Business Management  
and presented a paper on

*Perceived CSR & Job Satisfaction among Banking  
Employees in Pune*

Prof. Nutan H. Samdani

Conference Coordinator

Dr. Rajashree Shinde

Director



Anjuman Khairul Islam's

# Poona College

## OF ARTS, SCIENCE & COMMERCE



(Affiliated to Savitribai Phule Pune University)

K. B. Hidayatullah Road, Camp, Pune - 411001. Tel.: 020-26454240, Fax : 26453707 www.akipoonacollege.ac.in, principal@akipoonacollege.ac.in

### National Conference on

### Impact of ICT in Education

23<sup>rd</sup> and 24<sup>th</sup> January 2015

Organized by

Department of Electronic - Science

### Certificate

This is to certify that Dr./Mr./Ms. S. N. Kargaonkar.

of MIT Arts, Commerce & Science College, Alandi, Pune.

has attended the National Conference on **Impact of ICT in Education**

He/She has participated / resource person / chaired a technical session / presented a paper entitled,

ICT in Higher Education in India: Issues and Challenges.

  
Prof. Z. B. Pathan  
Organizing Secretary

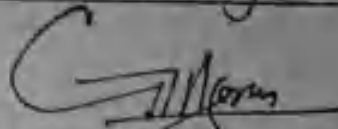
  
Dr. G. M. Nazeruddin  
Principal

3<sup>rd</sup> International Conference on Nanoscience and Nanotechnology (ICONN 2015)



**SRM**  
UNIVERSITY  
(Under section 3 of UGC Act 1956)

**SRM University**  
Kattankulathur - 603 203



*Certificate*

This is to certify that Mr. / Ms. / Dr. Punil Mahajan has  
Participated / Presented a Paper entitled H<sub>2</sub>S Gas Sensing Performance Of  
ZnO Thin Films Prepared By Spray CVD Technique in  
International Conference on Nanoscience and Nanotechnology (ICONN 2015) organized by Department of  
Physics and Nanotechnology, SRM University during 04 - 06 February 2015 in association with Shizuoka  
University, Japan and Institute of Geological and Nuclear Sciences, New Zealand, Co-sponsored by Science  
& Engineering Research Board (DST-SERB), Defence Research & Development Organization (DRDO) and  
Department of Biotechnology (DBT), Government of India.

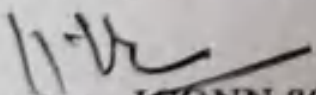
  
Convenor **ICONN 2015**

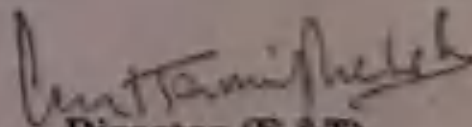
  
Director (E & T)



Shizuoka University, Japan



IGNS - New Zealand

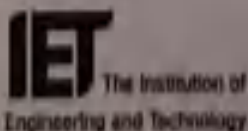

The Institution of  
Engineering and Technology



Government of India



Defence Research & Development Organization

# **MIT | Arts, Commerce & Science College**

**Maharashtra Academy of Engineering and  
Educational Research's**

**MIT Arts, Commerce and Science College,**

**Alandi (D) – 412 105.**

**< FINANCIAL SUPPORT FOR TEACHERS TO  
ATTEND CONFERENCE / WORKSHOP >**

**< A.Y. 2015-16 >**

## List of teachers receiving financial support (2015-16)

Sr. No.	Name of teacher	Name of conference/ workshop attended for which financial support provided	Name of the professional body for which membership fee is provided	Amount of support
1	Prof. Bhalchandra Pawar	One day workshop on "Calibration & Sensor"	Savitribai Phule Pune University	750
2	Prof. S. N. Kargaonkar	International Conference on Recent trends in Commerce, Management, Social Science & Humanities"	Commonwealth Vocational University & Leelawati College	1350
3	Prof. S. N. Kargaonkar	Seminar on 2015 International Mind Education	University of Pune	350
4	Prof. Sunil Mahajan	Workshop on Understanding of Origin & Endnote Software	University of Pune	450
5	Mr. Rahul Barathe	Seminar on ELSEVIER CONNECT	Elsevier Research Solutions	350
6	Mr. Rahul Barathe	National Workshop on Getting to Know More All About Open Access	AISSMS College	550
7	Prof. Pradip Pansare	Workshop on Instruction Schools for Teachers on Complex Analysis	National Centre for Mathematics & Bhaskaracharya Pratisthana, Pune	4200
8	Prof. Sunil Mahajan	Workshop on MEMS and Microsystems	MIT Pune	1300
9	Prof. Amit Tale	Workshop on Restructuring TY BCA Practical Slips & MCA (Com) Project Guidelines	Dr. D.Y. Patil ACS College, Pimpri	550
10	Prof. Akshada Kulkarni	Workshop on Restructuring TY BCA Practical Slips & MCA (Com) Project Guidelines	Dr. D.Y. Patil ACS College, Pimpri	550
11	Prof. Rashmi Lad	National Conference on Data Mining & ICT	Allana Institute	1500
12	Prof. Vaishali Kherdekar	National Conference on Data Mining & ICT	Allana Institute	1500
13	Dr. Shrishti Gangalay	International Conference on Innovations in Management & Technology	Dr. D. Y. Patil School of Management, Charholi, Pune	2000

## 802 MIT ACSC 15-16

Staff Training  
Ledger Account

1-Mar-2015 to 31-Mar-2016

Page 1  
Credit

Date	Particulars	Vch Type	Vch No.	Debit
2-4-2015	To <b>Cash</b> <i>Being Cash paid for registration fees for 2 days International Symposium on Physics and Technology of Sensors as per details attached - SUNIL MAHAJAN</i>	Payment	P-3	2,500.00
3-4-2015	To <b>Cash</b> <i>Being Cash paid for registration fees &amp; conveyance allowance for workshop dt 28. 11.2014 &amp; 29.11.2014 as per details attached - SUSHMA CHALKE</i>	Payment	P-6	1,100.00
28-8-2015	To <b>Cash</b> <i>being cash payment for 1 day workshop organized by university of pune as per details attached. - Prof B B Pawar</i>	Payment	P-176	750.00
24-10-2015	To <b>Cash</b> <i>being cash paid for registration fees &amp; conveyance allowance for workshop on view "understanding of Origin and Endnote Software Organized by university of pune dt 17.10.2015 as per details attached. - Prof Sunil Mahajan</i>	Payment	P-268	450.00
4-3-2016	To <b>Cash</b> <i>Being cash payment against Registration fees for conference organized by Allana Institute of Management Science dt 13.02. 2016 as per details attached - Rashmi Lad-HOD</i>	Payment	P-490	1,500.00
	To <b>Cash</b> <i>Being cash payment against Registration fees for conference organized by Allana Institute of Management Science dt 13.02. 2016 as per details attached - Vaishali Khedekar</i>	Payment	P-491	1,500.00
15-3-2016	To <b>Cash</b> <i>being cash payment against registration fees for conference organized by Dr D y Patil School of Management dt 03.02.2016 as per details attached - Dr Shrishti Gangalay</i>	Payment	P-517	2,000.00
	To <b>Cash</b> <i>Being cash payment against conveyance allowance - Dr D Y Patil college dt 04.01. 2016 as per detail attached - Amit Tale</i>	Payment	P-518	550.00
16-3-2016	To <b>Cash</b> <i>Being cash payment against conveyance allowance and registration fees for one day workshop organized by Dr D Y patil college dt 04.01.2016 as per details attached - Akshada Kulkarni</i>	Payment	P-524	550.00

Carried Over

10,900.00



Principal  
MIT Arts, Commerce & Science College  
Alandi, Pune - 412 105.

continued

Date	Particulars	Vch Type	Vch No.	Debit	Page 2 Credit
	Brought Forward			10,900.00	
By	Closing Balance			10,900.00	10,900.00
				<b>10,900.00</b>	<b>10,900.00</b>

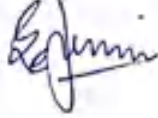

Principal  
MIT Arts, Commerce & Science College  
Alandi, Pune - 412 105.



**802 MIT ACSC 15-16**  
**Seminar & Conferences**  
 Ledger Account

1-Apr-2015 to 31-Mar-2016

Page 1  
Credit

Date	Particulars	Vch Type	Vch No.	Debit
28-8-2015	To <b>Cash</b> <i>being cash payment for registration fees and conveyance allowance for 1 day international conference organized by commonwealth vocational Uni &amp; Leelawati college as per details attached. - S N Kargaonkar</i>	Payment	P-177	1,350.00
28-10-2015	To <b>Cash</b> <i>Being cash paid for conveyance allowance for seminart on view "2015 International Mind Education Seminar" organized by UNIVERSITY of pune as per details attached - Shriram Kargaonkar</i>	Payment	P-276	350.00
18-11-2015	To <b>Cash</b> <i>Being cash paid for conveyance allowance for workshop on view ELSEVIER CONNECT SEMINAR organized by elesavier connect as per details attached - Rahul Barathe</i>	Payment	P-312	350.00
	To <b>Cash</b> <i>Being cash paid for conveyance allowance and registration fees for workshop on view "Getting to know more all about open Access" organized by all India shri shivaji memorial society college as per details attached - Rahul Barathe</i>	Payment	P-313	550.00
22-12-2015	To <b>BOI 062920110000010 - Payment A/c</b> <i>Ch. No. :000100 Being Payment against Conveyance for Workshop Pradip Pansare</i>	Payment	000100	4,200.00
31-12-2015	To <b>Cash</b> <i>being cash paid for Conveyance allowance and registration fees for state level seminar on view Effective use of IT Office management organized by B N sarda College Sangamner dt 19.12.2015 as per details attached - Sangeeta Kulkarni - Student section</i>	Payment	P-379	388.00
4-1-2016	To <b>Cash</b> <i>Being cash paid for conveyance allowance and registration fees for state level seminar on view effective use of IT Office management organized by B N sarda college sangamner dt 19.12.2015 as per details attached - Sarika Padwal - assistant librarian</i>	Payment	P-385	413.00

Carried Over

7,601.00





Principal  
 MIT Arts, Commerce & Science College  
 Alandi, Pune - 412 105.

continued ...

802 MIT ACSC 15-16

Seminar & Conferences Ledger Account 1-Apr-2015 to 31-Mar-2016

Date	Particulars	Vch Type	Vch No	Debit	Page 2 Credit
	Brought Forward			7,601.00	
4-3-2016	To Cash <i>Being cash paid for Conveyance Allowance and Registration Fees for 2 day Workshop on view MEMS and microsystems organized by mahashtra Institute Pune dt 12.02.2015 &amp; 13.02.2016 as per details attached - Sunil mahajan HOD</i>	Payment	P-492	1,300.00	
By	Closing Balance			8,901.00	8,901.00
				<b>8,901.00</b>	<b>8,901.00</b>

*[Handwritten Signature]*



*[Handwritten Signature]*  
Principal  
MIT Arts, Commerce & Science College  
Alandi, Pune - 412 105.

# Audit Statements for F.Y. - 2015-16

6	Gratuity	23,73,208.00
7	Admission Cancellation	1,05,800.00
8	Advertisement expenses	37,19,554.00
9	Affiliation fees	15,800.00
10	Audit Fee	17,175.00
11	Bank commission and charges	8,821.51
12	Books and periodicals	2,06,125.00
13	Consumable goods	2,03,502.00
14	Conveyance expenses	1,55,225.00
15	CPF admin charges	1,29,270.00
16	Electricity Charges	9,93,035.00
17	Exam expenses	1,83,382.00
18	Gathering expenses	6,48,768.00
19	Industrial Visit	30,300.00
20	Interest on equipments T..	2,10,502.00
21	Interest on overdraft	6,64,824.00
22	Journals subscription	1,17,000.00
23	Loan Processing Charges	5,44,840.00
24	Office Expenses	2,62,523.00
25	Placement activities	58,834.00
26	Postage and courier	14,019.00
27	Printing and stationery	5,82,446.00
28	Repairs and maintenance	2,07,585.00
29	Seminar & Conference	63,638.00
30	Sports and other activities	42,180.00
31	Staff training and welfare	4,042.00
32	Students Activities & Welfare	1,66,161.00
33	Telephone and Internet charges	3,42,482.00
34	University fees	2,75,082.00
<b>TOTAL RS.</b>		<b>5,48,97,820.51</b>



11,52,000.00  
 12,09,664.00  
 11,52,000.00  
 206,125.00  
 11,52,000.00



# Savitribai Phule Pune University

One Day Workshop on

## “Calibration of Sensors”

8<sup>th</sup> August, 2015

### *Certificate of Participation*

This is to certify that Prof. B. B. Pawar

has participated in the one day workshop on “Calibration of Sensors” jointly organized by

**Centre for Sensor Studies , Savitribai Phule Pune University, Pune and CLIC-IN**

**Calibration Laboratory, Pune.**

**N.G. Inamdar**  
CLIC-IN Calibration  
Laboratory, Pune

**Prof. A. B. Shinde**  
CLIC-IN Calibration Laboratory,  
Pune

**INTERNATIONAL CONFERENCE ON RECENT TRENDS IN  
Commerce, Management, Social Science and Humanities**

**CERTIFICATE**

This is to Certify that

Prof. Shwilam Kargaonkar.

of

M.I.T. Arts, Commerce & Science College Aladi, Pune.

has participated and presented the paper entitled

Review of statistical process control.

at the International Conference on Recent Trends in Commerce,  
Management, Social Science and Humanities  
held on 10<sup>th</sup> August, 2015 at MCCIA, Tilak Road, Pune, INDIA.

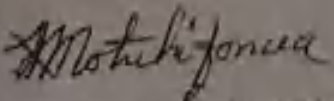
  
Conference Chairperson  
Dr. Keaci Mntuhifonua

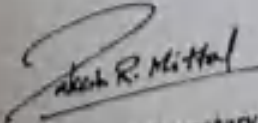
  
Conference Secretary  
Prof. Rakash Mittal

# Certificate of Participation

2015 International Mind Education Seminar

KARGADNKAR SHRIRAM

This is to certify that he/she has participated in  
the International Mind Education Seminar for  
Educational Leaders, hosted by  
International Mind Education Institute  
held at Savitribai Phule Pune University,  
on Oct 16<sup>th</sup>, 2015.

*Kim jae hong*

President of IMEI

International Mind Education Institute  
국제마인드교육원

R

Shot on realme C1



A workshop on



Understanding of Origin and EndNote Software

Organized by

**Center for Sensor Studies**

**Savitribai Phule Pune University, Pune**

## **Certificate of Participation**

This is to certify that Sunil Mahajan.....  
has attended a workshop on “**Understanding of Origin and  
EndNote Software**” held at Centre for Sensor Studies on  
October 17, 2015.

  
**Prof. A. D. Shaligram**  
Co-ordinator

Centre for Sensor Studies

Savitribai Phule Pune University Pune 411007



**ElsevierConnect**  
Empowering Knowledge

# Certificate Of Participation

This is to certify that

*Mr. Rahul P. Barathe*

has participated in

“Elsevier Connect Seminar”

held on *27 OCT 2015*

at *Hotel pride*

**Vinod Kaw**

Senior Manager – South Asia  
Elsevier Research Solutions

**Manish Uniyal**

Marketing Manager – South Asia  
Elsevier Research Solutions



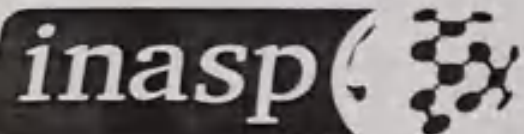

All India Shri Shivaji Memorial Society's  
College of Engineering, Pune-1

**One Day National Level Workshop on  
"Getting to know more all about Open Access" 19 October 2015**

# Certificate

This is to certify that Dr / Prof / Mrs / Mr... Rahul Barathe  
of MIT Arts & Commerce, Science, Aalandi, Pune  
Participated in workshop "Getting to know more all about Open Access" on 19 October 2015 at  
All India Shri Shivaji Memorial Society's College of Engineering, Kennedy Road, Pune-1

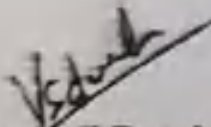
  
Vrushi Dandawate  
Organizing Secretary

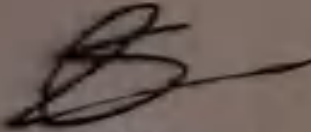
  
Dr S P Datta  
Principal



**National Centre for Mathematics**

www.ncmath.org

(A joint centre of TIFR and IIT Bombay)

**Instructional School for Teachers on "Complex Analysis"**

(16<sup>th</sup> - 28<sup>th</sup> November, 2015)



**BHASKARACHARYA PRATISHTHANA, PUNE**



**Certificate**

This is to certify that Mr. Pradip Dattatraya Pansare of  
M.I.T. Arts, Commerce and Sci. College, Alandi (D), Pune has

participated in the Instructional School for Teachers on "Complex Analysis"  
organized at the Bhaskaracharya Pratishthana, Pune, during 16<sup>th</sup> - 28<sup>th</sup> November, 2015.

*Diganta Borah*

Diganta Borah  
Coordinator

*V. M. Sholapurkar*

V. M. Sholapurkar  
Coordinator

MAEER's MIT GROUP OF INSTITUTIONS PUNE INDIA



# National Workshop on MEMS and Microsystems (NWMEMS & MS)



12th & 13th February 2016

## Certificate

This is to certify that, Prof./Dr./Mr./Ms./Mrs. Sunil Mahajan

From MITACSE, Alandi

has participated in Two day National workshop on, "MEMS and Microsystems" jointly organized by,  
Maharashtra Institute of Technology Pune, MAEER's Arts Commerce and Science College Pune and  
The Pune Chapter of Institute of Smart Structures and Systems (ISSS).

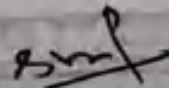
  
Prof. Sunil Chaudhari  
Convener

  
Dr. T. N. More  
Co-Chairman

  
Dr. L. K. Kshirsagar  
Chairman

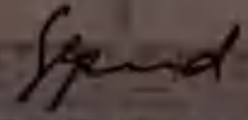
  
Dr. Guruprasad  
Chairman, ISSS (Pune Chapter)



Dr D.Y. Patil Vidya Pratishthan Society's  
**DR. D.Y. PATIL ARTS, COMMERCE AND SCIENCE COLLEGE**  
**Pimpri , Pune -18**  
**(NAAC Accredited B++ Grade)**



&  
**DEPARTMENT OF COMMERCE**  
**SAVITRIBAI PHULE PUNE UNIVERSITY**  
ORGANIZES

**ONE DAY WORKSHOP ON**  
"Restructuring of T.Y.B.C.A Practical slips and M.C.A(Commerce) Project Guidelines"

## *Certificate*

This is to certify that Prof/Dr/Mrs/Miss Amit Tale  
of MIT ACS College, College / Institute has participated in  
**One Day Workshop** on "Restructuring of T.Y.B.C.A Practical slips and M.C.A (Commerce) Project  
**Guidelines**" conducted on 4th January 2016 at Dr. D.Y. Patil Arts, Commerce and Science College Pimpri.

**Dr. Ranjit Patil**  
Vice Principal & Co-ordinator

**Dr. Snehal Agnihotri**  
Principal

**Dr. Sanjay Kaptan**  
Professor & Head  
Department of Commerce, SPPU



Dr. D.Y. Patil Vidyapeeth Society's  
**DR. D.Y. PATIL ARTS, COMMERCE AND SCIENCE COLLEGE**  
Pimpri, Pune -18  
(NAAC Accredited B++ Grade)



&  
**DEPARTMENT OF COMMERCE**  
**SAVITRIBAI PHULE PUNE UNIVERSITY**  
ORGANIZES

**ONE DAY WORKSHOP ON**  
"Restructuring of T.Y.B.C.A Practical slips and M.C.A(Commerce) Project Guidelines"

## Certificate

This is to certify that Prof/Dr/Mrs/Miss Akshada Kulkarni

of MIT ACS College College / Institute has participated in

**One Day Workshop on "Restructuring of T.Y.B.C.A Practical slips and M.C.A (Commerce) Project Guidelines"** conducted on 4th January 2016 at Dr. D.Y. Patil Arts, Commerce and Science College Pimpri

  
**Dr. Ranjit Patil**  
Vice Principal & C.O. (Acad.)

  
**Dr. Snehal Agnihotri**  
Principal

**Dr. Sanjay Kaptan**  
Professor de Hons  
Department of Commerce, SPPU



M.C.E Society's

# Allana Institute of Management Sciences



Camp, Pune

## 3<sup>rd</sup> National Conference on Data Mining & ICT

In association with Savitribai Phule Pune University

### *Certificate*

This to certify that **Prof. Rashmi Lad**

from MIT Arts, Commerce & Science College, Pune has presented research paper on

**Current Status of Cognitive Psychology & Cognitive Neuroscience with Artificial**

**Neural Network in the 3<sup>rd</sup> National Conference on Data Mining (NCDM 15-16).**

**Dr. Prof. R. Ganesan**  
Director, AIMS



**Dr. H. S. Acharya**  
Professor, MCA

**Prof. Jawed Khan**  
HOD, MCA

20  
1



**Allana Institute of  
Management Sciences**

Camp, Pune

**3<sup>rd</sup> National Conference on  
Data Mining & ICT**

In association with Savitribai Phule Pune University

*Certificate*

This to certify that **Prof. Vaishali Kherdekar**

*from M.I.T. Arts, Commerce, Science College, Pune has presented research paper on  
An Implementation of Data ware house Transformation Model for Banking system  
through Pentaho ETL in the 3<sup>rd</sup> National Conference on Data Mining (NCDM 15-16).*



**Dr. Prof. B. Ganesh**  
Chairman, AIMS



**Dr. H. N. Acharya**  
President, MCA



**Prof. Jawed Khan**  
HOD, MCA

Dr D Y Patil Educational Enterprises Charitable Trust's

**Dr D Y Patil School of Management  
Dr D Y Patil School of MCA**

D Y Patil Knowledge City, Charnoli (Bk), Via Lohegaon, Pune-412105



**AJEENKYA**  
D Y PATIL UNIVERSITY



**INTERNATIONAL CONFERENCE  
"INCUBATION"**

on  
**'Innovation in Management and Technology'**

in Association with



**Certificate**

This is to certify that Dr. / Prof. / Mr. / Mrs. / Ms. Dr. Shriichi Ganguly of  
\_\_\_\_\_ has participated/presented research paper entitled \_\_\_\_\_

in International Conference 'INCUBATION' held on 16<sup>th</sup>, 17<sup>th</sup> and 18<sup>th</sup> Feb 2016.

*Haladar*  
**Prof. (Dr.) O.P. HALDAR**  
Conference Convener  
Professor, Dr D Y Patil School of Management,  
Lohegaon, Pune, Maharashtra, India

*Khedkar*  
**Prof. (Dr.) E.B. KHEDKAR**  
Conference Chairman  
Vice Chancellor, Ajeenkya D Y Patil University, Lohegaon,  
Pune, Maharashtra, India  
Dean, Faculty of Management, Savitribai Phule Pune University,  
Pune, Maharashtra, India





**Maharashtra Academy of Engineering and  
Educational Research's**

**MIT Arts, Commerce and Science College,**

**Alandi (D) – 412 105.**

< FINANCIAL SUPPORT FOR TEACHERS TO  
ATTEND CONFERENCE / WORKSHOP >

< A.Y. 2016-17 >

## List of teachers receiving financial support (2016-17)

Sr. No.	Name of teacher	Name of conference/ workshop attended for which financial support provided	Name of the professional body for which membership fee is provided	Amount of support
1	Prof. S. N. Kargaonkar	State Level Workshop on "Research Methods & Tools Required in Data Analysis	MAEER's ACS College, Pune	1100
2	Prof. Sunil Mahajan	Workshop on Intellectual Property Rights	RUSA & Savitribai Phule Pune University	350
3	Prof. Sunil Mahajan	State Level Seminar on " Role of Advanced Sensors in the Development of Smart City"	Modern College, Pune	650
4	Prof. S. N. Kargaonkar	State Level Workshop on " Bioinformatics & Biostatistics Using R-Software".	S P College, Pune	700
5	Mr. Rahul Barathe	Workshop on "Doors are open: Knowledge about Open Access"	AISSM Society's College of Engineering, Pune	750
6	Prof. Madhukar Wakhare & Prof. Avinash Choure	International Conference on Agriculture & Biotechnology	IRAJ Research Forum, Pune	6600
7	Mr. Rahul Barathe	Workshop on Open Access & DelNet for Library	Bharati Vidyapeeth, Pune	300
8	Mr. Rahul Barathe	Conference on Advancements in IT management	MITACSC	1000
9	Mr. Rahul Barathe	Seminar on Socio-Eco Innovation & its Application for the Development of Smart City	MITACSC	500
10	Mr. Rahul Barathe	Workshop on Decoding Accreditation	Yashwi Education Society's Institute of Management Sciences, Chinchwad	500
11	Prof. Madhukar Wakhare	Conference on Introduction & Applications of Internet of things using Raspbery	NBN Sinhgad School of Engineering	1500
12	Prof. Mangesh Bhople	Orientation Programme on "Village Sustainability"	Gokhale Institute of Politics	867

## 802 - (16-17) MIT ACSC

## Staff Welfare

Ledger Account

1-Apr-2016 to 31-Mar-2017

Page 1  
Credit

Date	Particulars	Vch Type	Vch No.	Debit
9-9-2016	To Cash being cash paid for conveyance allowance and registration fees for 2 days workshop dt 30.08.2016 & 31.08.2016 as per details attached - S N Kargaonkar	Payment	P-255	1,100.00
	To Cash being cash paid for conveyance allowance for workshop on interlectual property rights dt 01.09.2016 as per details attached - Sunil Mahajan	Payment	P-256	350.00
28-9-2016	To Tds- Chandramukhi Garden - 2% being expses against refreshment for Faculty Development Program dt 29.04.2016 Barren Shaikh	Journal		1,000.00
5-10-2016	To Cash being cahs paid for conveyance allowance and registration fees for seminar dt 28.09.2016 as per details attached - prof S P Mahajan	Payment	P-311	650.00
13-10-2016	To Cash being cash paid for conveyance allowance for two days state level workshop dt 30.09.2016 & 1.10.2016 as per details attached - S N Kargaonkar	Payment	P-326	700.00
5-12-2016	To BOI 062920110000010 - Payment A/c 3233 being training / workshop expenses paid to madhukar wakhare. registration fees	Payment	3233	6,600.00
8-12-2016	To Cash being cash paid for registration fees against conference new opportunities for START UP in MAKE IN INDIA organized by Government of Maha & Economic Deve Council as per dtails attached - Reshma Somvanshi	Payment	P-441	300.00
	To Cash being conveyance allowance paid for attending annual MSME Conference on START UP in MAKE IN INDIA dt 17.10.2016 as per details attached - Reshma Somvanshi	Payment	P-442	975.00
23-12-2016	To Cash being cash paid for registration fees against one day workshop open access & delinet for library dt 20.10.2016 21.10.2016 & 12.11.2016 as per details attached - Rahul Barathe - librian	Payment	P-469	750.00

Carried Over

12,425.00





continued ...

Principal  
MIT Arts, Commerce & Science College  
Alandi, Pune - 412 105.

Date	Particulars	Vch Type	Vch No.	Debit	Credit
	Brought Forward			12,425.00	
23-12-2016	To Cash <i>being conveyance allowance paid for attending delnet &amp; open access workshop for library one day workshop dt 20.10.2016 a21.2016 &amp; 12.11.2016 as per details attached - Rahul Barathe Librarian</i>	Payment	P-470	300.00	
20-1-2017	To BOI 062920110000010 - Payment A/c <i>5026 being payment for registration fees against conference, introduction and applications of internet of things using raspberry organized by NBN sinhgad school of engineering as per details attached - Madhukar Wakhare</i>	Payment	5026	1,500.00	
3-3-2017	To Cash <i>being cash payment for refistration fees against seminar onsocio-eco innvocation &amp; its application for the development of smart city organized by mit acsc as per details attached - Sanka padwal</i>	Payment	P-624	500.00	
	To Cash <i>being cash payment for refistration fees against seminar onsocio-eco innvocation &amp; its application for the development of smart city organized by mit acsc as per details attached - rahul barathe</i>	Payment	P-625	500.00	
	To Cash <i>being cash payment for registration fees against workshop on decoding accreditation organized by yashaswi edcation society as per details attached - Rahul Barathe</i>	Payment	P-626	500.00	
	To Cash <i>being cash payment for registration fees against conference on advancements in IT management organized by mitacsc as per details attached - Rahul Barathe</i>	Payment	P-627	1,000.00	
	To Cash <i>being cash payment for registration fees against workshop on library best practices organized by flame univeristy as per details attached - Sanka padwal</i>	Payment	P-628	500.00	
	To Cash <i>being cash payment for registration fees against conference on advancements in it and management organized by mitacsc as per details attached - sanika padwal</i>	Payment	P-629	1,000.00	
8-3-2017	To Cash <i>mangesh bhople</i>	Payment	P-645	867.00	
By	Closing Balance			19,092.00	19,092.00
				19,092.00	19,092.00





Principal  
MIT Arts, Commerce & Science College  
Alandi, Pune - 412 105.

**MIT ACSC 19-20**  
**Staff Welfare & Development**  
Ledger Account

1-Apr-2019 to 30-Apr-2019

Date	Particulars	Vch Type	Vch No.	Debit	Page 1 Credit
15-4-2019	To Cash	Payment	P-22	500.00	
	To Cash	Payment	P-21	500.00	
17-4-2019	To Cash	Payment	P-26	1,750.00	
				2,750.00	
	By Closing Balance				2,750.00
				2,750.00	2,750.00

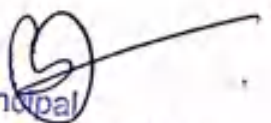

  
**Principal**  
MIT Arts, Commerce & Science College  
Alandi, Pune - 412 105.

# Audit Statement for F.Y.: 2016-17

## SCHEDULE NO. 10

### EXPENDITURE ON OBJECT OF TRUST

SR. NO.	PARTICULARS	AMOUNT RS.
1	Salary teaching	33,280,172.00
2	Salary non teaching	11,300,045.00
3	CPF employer	2,012,397.00
4	Honorarium & professional fees	348,112.00
5	Houskeeping & Security	3,768,885.00
6	Advertisement expenses	4,496,492.00
7	Affiliation fees	909,347.00
8	Audit Fee	17,250.00
9	Campus Expenses	75,060.00
10	Consumable Goods	11,527.00
11	Gratuity 16-17	589,617.00
12	News & Periodicals	68,169.00
13	Industrial Visit	7,144.00
14	Electricity Charges	7,161,740.00
* 15	Interest on BOB OD A/c No. 000101	7383.00
16	Interest on BOB TL 1 A/c 2211	1787421.00
17	Interest on BOI OD 8685(144)	31472.00
18	Interest on BOI TOD 053027110000021	4068.00
19	Interest on Federal Bank TL 2 A/c 2581	233134.00
20	Interest on Federal Bank TL A/c 2631	1143.00
21	Interest on HDFC OD A/c 575	4872.00
22	Interest on HDFC STL 310003	6525.00
23	Interest on HDFC TL 001	3290166.86
24	Interest on HDFC TL 003	4683665.62
25	Int on Federal Bank OD 2086	175.00
26	Loan Prepayment Charges	3302102.00
27	Loan Processing Charges	1826119.16
28	Office Expenses	482,612.01
29	Placement activities	15,013.00
30	Printing and stationery	791,240.00
31	Repairs and maintenance	203,064.00
32	Vehicles diesel	28,044.00
33	Sports and other activities	24,320.00
34	Staff training and welfare	126,627.00
35	Students Activities & Welfare	902,326.00
36	Telephone and internet charges	167,690.00
37	Travelling expenses	165,417.00
<b>TOTAL RS.</b>		<b>76,120,556.65</b>





MAEER'S  
ARTS, COMMERCE & SCIENCE COLLEGE PUNE INDIA

ESTD - 2004



University of Pune

(Accredited by NAAC with 'A' Grade)

## Two Days State Level Workshop

on

### "Research Methods & Tools required in Data Analysis"

(30th & 31st August 2016)

Under the Quality Improvement Program of  
Savitribai Phule Pune University

# Certificate

This is to certify that, Prof/Dr./Mr./Ms./Mrs. Shrinani Kargsonkar of

MIT Arts, Commerce & Science College (Mandla) college has attended Two Days State Level Workshop on

"Research Methods & Tools required in Data Analysis" organized by Department of computer science,

MAEER'S Arts, Commerce & Science College, Pune.

Mr. Sachin Bhoite  
Convener  
Course Coordinator  
Dept. of Computer Science

Dr. T. N. More  
Principal,  
MAEER'S Arts, Commerce  
& Science College, Pune

Rahul V. Karad  
Vice President,  
MAEER'S MIT Group of Institutions,  
Pune



Progressive Education Society's

**Modern College of Arts, Science and Commerce**

Ganeshkhind, Pune - 411016



# Certificate

This is to certify that Prof. /Dr./Mr./Mrs. Sunil Mahajan.

of MIT ACS College, Alandi, Pune

has participated in one day State Level Seminar on

**" Role of Advanced Sensors in the Development of Smart City "**

on Wednesday, 28<sup>th</sup> September 2016

Organized by

**Department Of Electronic Science**

Under Quality Improvement Programme of Savitribai Phule Pune University  
in association with

Society for promotion of Excellence in Electronics Discipline (SPEED)

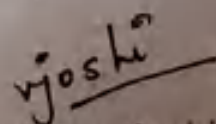

Prof. Varsha Joshi  
Head,  
Department of Electronics

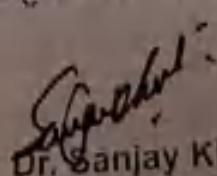

Dr. Sanjay Kharat  
Principal  
Modern College, Pune-16

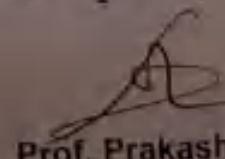

Prof. Prakash Dixit  
Dy. Secretary, P. E. Society,  
Visitor, Modern College, Pune-16

Prof. Suresh Todkar  
Jt. Secretary, P. E. Society,  
L. M. C. Chairman,  
Modern College, Pune-16

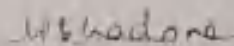

Prof. Mrunalini Bhadane  
Coordinator  
State Level Seminar







Shikshana Prasarak Mandali's

**SIR PARASHURAMBHAU COLLEGE, PUNE-30**

Best College Award - SPPU, NAAC Re-Accredited 'A' Grade

100

Two Day State Level Workshop on  
"Bioinformatics and Biostatistics Using R-Software"  
30<sup>th</sup> September - 1<sup>st</sup> October 2016

Sponsored by

(Quality Improvement Program, Planning and Development, Savitribai Phule Pune University, Pune)

## Certificate

This is to certify that Mr. Aniram N. Kargasurkar  
of the Department of Statistics, M.I.T., A.C.S.C., Alandi has attended the  
workshop as a ~~Resource person~~ / Participant / ~~Volunteer~~ organized by  
Department of Zoology & Department of Statistics, S. P. College, Pune - 411 030.

**Dr. Manisha Modak**  
Co-ordinator (Workshop)  
S. P. College, Pune

**Dr. Dilip Sheth**  
Principal  
S. P. College, Pune



All India Shri Shivaji Memorial Society's  
College of Engineering, Pune - 1



inasp



## NATIONAL WORKSHOP

"Doors are open : Know about Open Access" 20-21 October 2016

# Certificate

This is to certify that Dr/ Prof/Mrs/Mr Barathe Rahw  
of MIT Arts Commence & Science College, Alandi, Pune participated in  
workshop "Doors are open : Know about Open Access" 20-21 October 2016 at All India Shri Shivaji Memorial  
Society's College of Engineering, Kennedy Road, Pune-1

Vrushali Dandawate  
Organizing Secretary, AISSMS COE

Dr S P Danao  
Principal, AISSMS COE

**IRF**

**IRAJ RESEARCH FORUM**  
In Association with

**INSTITUTE OF RESEARCH AND JOURNALS**

International Conference on  
Agriculture and Biotechnology

**ICABT-PUNE**

*Certificate*

*This is to certify that A.G.Choure has presented a paper entitled "Design of Framework for Agriculture Web Service" at the International Conference on Agriculture and Biotechnology (ICABT) held at Pune on 20<sup>th</sup> November 2016.*

AC-CABT-NGPR-16116-711

Paper ID



*[Signature]*  
Chairman

INSTITUTE OF RESEARCH AND JOURNALS



INSTITUTE OF RESEARCH AND JOURNALS

INSTITUTE OF RESEARCH AND JOURNALS

INSTITUTE OF RESEARCH AND JOURNALS

INSTITUTE OF RESEARCH AND JOURNALS

INSTITUTE OF RESEARCH AND JOURNALS





*Bharati Vidyapeeth Deemed University,  
New Law College  
Pune, Maharashtra*





**DELNET**  
*Developing Library Network  
New Delhi*

## **CERTIFICATE**

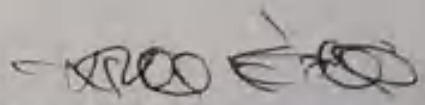
This is to certify that Mr. Rahul Barathe, Librarian  
of MIT Art's Commerce & Science College, Alandi, PUNE  
has participated in the *One-Day Workshop on 'DELNET: Resources, Services & Facilities  
and Open Source Software for Libraries'* organised by **DELNET** in collaboration with  
*Bharati Vidyapeeth Deemed University, New Law College, Pune, Maharashtra* and held  
at BVDU, NLC, Pune, Maharashtra on November 12, 2016.

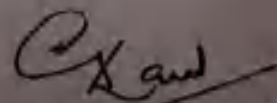
  
Mr. Subhash Deshmukh  
University Librarian  
BVDU, Pune

  
Dr. Sangeeta Kaul  
Network Manager  
DELNET, New Delhi

  
Dr. H. K. Kaul  
Director  
DELNET, New Delhi

# MIT

Arts, Commerce  
& Science College



Two Days National Level Conference

on

**'Advancements in IT and Management'** (AIM 2016)

Organized by

**Department of Computer Application**

*In Association with Savitribai Phule Pune University*

## CERTIFICATE

This is to certify that Mr. Rahul Bawathe  
of MIT ACSC Alandi (D), Pune has participated in  
two days National Level Conference on "Advancements in IT and Management" held on 2<sup>nd</sup> and 3<sup>rd</sup>  
December 2016. He / She has presented a paper entitled Use of Green Library  
In Academic Institution

  
Prof. Akshada Kulkarni  
Convener

  
Dr. B. B. Waphare  
Principal

**MIT** | Arts, Commerce  
& Science College

Alandi (D), Pune -412 105.



(Affiliated to Savitribai Phule Pune University)

10<sup>th</sup> Year going with Persistent Evolution In Education and Research  
Organizes

**Two Days State Level Seminar**  
on

**“Socio-Economic innovation and its application for the development of Smart City.”**

Sponsored by

Savitribai Phule, Pune University

**CERTIFICATE**

This is to certify that Dr./Mr/Mrs/Ms. Rahul P. Barathe  
of MIT ACSC Alandi (D) Pune has participated as a Resource Person/  
Open Source

Chair Person / Researcher presented/ submitted a paper on in Smart City in two days State level Seminar on

**“SOCIO-ECONOMIC INNOVATION AND ITS APPLICATION FOR THE DEVELOPMENT OF SMART CITY”**  
organised by Department of Arts and Commerce, of MIT Arts Commerce and Science College, Alandi(D), Pune  
on 16<sup>th</sup> & 17<sup>th</sup> December, 2016. His / Her Participation / Presentations is highly appreciated.

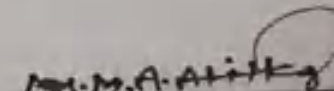
  
Prof. Manasi Atitkar

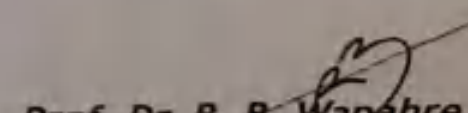
  
Prof. Dr. B. B. Wapahre  
Principal

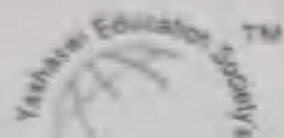

Yashaswi Education Society's  
**International Institute of Management  
Science, Chinchwad, Pune**

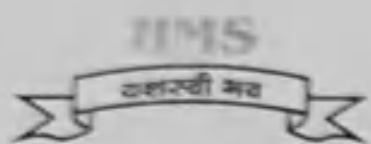

(Approved by AICTE, Ministry of HRD, Govt. of India, Recognised by DTE, Govt. of Maharashtra & Affiliated to Savitribai Phule Pune University, ISO 9001 Certified Institute)

**Certificate of Participation**

*This is to certify that*

Ms. / Mr. / Mrs. / Dr. Rahul Popat Bazeathe  
of MIT Arts commerce & science college Alandh

participated in the One Day workshop '**Decoding Accreditation**' organized by  
Yashaswi Education Society's International Institute of Management Science, held on 23<sup>rd</sup> December 2016

Date: 23<sup>rd</sup> Dec 2016

Place: Pune

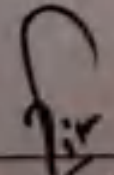
  
Vishwesh Kulkarni  
President

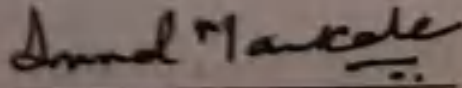
  
Dr. Amod Markale  
Director



SINHGAD TECHNICAL EDUCATION SOCIETY  
NBN Sinhgad Technical Institute Campus  
SINHGAD SCHOOL OF ENGINEERING  
(Approved by AICTE, New Delhi; Recognized by Government of Maharashtra; Affiliated to Savitribai Phule Pune University)  
Vadgaon-Ambegaon (Bk), Off Sinhgad Road, Pune - 411041



## DEPARTMENT OF INFORMATION TECHNOLOGY

One Week National Level Short Term Training Program on

Introduction & Application of **Internet of Things Using Raspberry Pi**

# Certificate

OF PARTICIPATION

This certificate is being awarded to

Dr / Prof / Shri / Smt Madhukar Malhaxi Wakhare  
from MIT Arts, commerce, science college, Alandi

for actively participating in ISTE Approved & BCUD, SPPU Sponsored One Week  
STTP on "Introduction and Application of Internet of Things Using Raspberry Pi"  
during 26<sup>th</sup> to 30<sup>th</sup> Dec. 2016 organized by  
Department of Information Technology, NBN Sinhgad School of Engineering, Pune.

APPROVED BY



ISTE, New Delhi

SPONSORED BY



BCUD, Savitribai Phule Pune University

Rahane  
(Mr. W. P. Rahane)  
Coordinator

Patil  
(Prof. S. P. Patil)  
Convener

Prasad  
(Dr. R. S. Prasad)  
Principal



ORIENTATION PROGRAMME  
ON  
"VILLAGE SUSTANABILITY"

*Certificate of Participation*

This is to certify that Mr/Mrs/Ms Prof. Mangesh Bhople  
has participated in the Orientation Programme on "**Village Sustainability**" organized by the  
Dr. D. R. Gadgil Centre for Sustainable Village Development, Gokhale Institute of Politics and  
Economics (GIPE), Pune, during 4<sup>th</sup> – 5<sup>th</sup> February 2017.

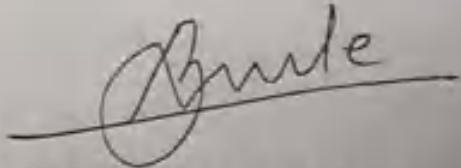
  
Prof. Dr. K. N. Bavale  
Programme Coordinator

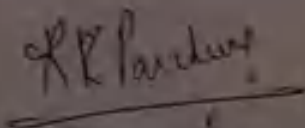
  
Prof. Rajas Parchure  
Offg. Director



**Maharashtra Academy of Engineering and  
Educational Research's**

**MIT Arts, Commerce and Science College,**

**Alandi (D) – 412 105.**

< FINANCIAL SUPPORT FOR TEACHERS TO  
ATTEND CONFERENCE / WORKSHOP >

< A.Y. 2017-18 >

## List of teachers receiving financial support (2017-18)

<b>Sr. No.</b>	<b>Name of teacher</b>	<b>Name of conference/ workshop attended for which financial support provided</b>	<b>Name of the professional body for which membership fee is provided</b>	<b>Amount of support</b>
1	Prof. Shubhangi Gaikar	Programme on Arduino Development	India's FIRST Robotics, Aundh, Pune	2500
2	Prof. Pallavi Mahagaonkar	Programme on Arduino Development	India's FIRST Robotics, Aundh, Pune	2500
3	Prof. Vandana Pagar	Programme on Arduino Development	India's FIRST Robotics, Aundh, Pune	2500
4	Mr. Rahul Barathe	Workshop on " Information anagement for research & education oriented libraries"	AISSMS College of Engineering, Pune	3500

**802 - (17-18) MIT ACSC**  
**Staff Welfare & Development**  
 Ledger Account

1-Apr-2017 to 31-Mar-2018

Page 1  
Credit

Date	Particulars	Vch Type	Vch No.	Debit	Credit
28-4-2017	To <b>Cash</b> <i>Being cash payment for GST seminar Registration fees dt 27 04, 2017 as per bill attached. - Deepali Jogdand</i>	Payment	P-38	1,200.00	
6-7-2017	To <b>BOI 062920110000010 - Payment A/c</b> <i>5204 Being payment for registration fees against program on Arduino Developemnt organized by SSPU as per details attached - Pallavi Mahagaonkar</i>	Payment	5204	2,500.00	
	To <b>BOI 062920110000010 - Payment A/c</b> <i>5204 Being payment for registration fees against program on Arduino Developemnt organized by SSPU as per details attached - Mrs. Shubhangi Gaikar</i>	Payment	5207	2,500.00	
	To <b>BOI 062920110000010 - Payment A/c</b> <i>5204 Being payment for registration fees against program on Arduino Developemnt organized by SSPU as per details attached - Vandana Pagar</i>	Payment	5205	2,500.00	
31-1-2018	To <b>BOI 062920110000010 - Payment A/c</b> <i>013205 Being payment against Registration Fees for Internal Workshop. " Information Management for Reserch and Education Oriented Libraies" dt on 18.12.2017 to 22. 12.2017 as per details attached - Rahul Barathe</i>	Payment	013205	3,500.00	
				12,200.00	
	By <b>Closing Balance</b>			12,200.00	12,200.00
				12,200.00	12,200.00



MIT Arts, Commerce & Science College  
Alandi, Pune - 412 105.

# Audit Statement for F.Y. - 2017-18

## SCHEDULE NO. 10

### EXPENDITURE ON OBJECT OF TRUST

SR. NO.	PARTICULARS	AMOUNT RS.
1	Salary teaching	40,372,944.00
2	Salary non teaching	14,998,113.00
3	CPF employer	2,375,240.00
4	Honorarium & professional fees	389,272.00
5	Houskeeping & Security	7,935,504.56
6	Advertisement expenses	4,176,136.00
7	University Fees	326,045.00
8	Audit Fee	1,000.00
9	Campus Expenses	597,308.00
10	Consumable Goods	209,975.17
11	Gratuity 16-17	587,132.19
12	Seminar & Workshop	77,252.20
13	Industrial Visit	24,852.00
14	Electricity Charges	2,676,415.00
15	Interest on BOI OD 8658- 144	28181.92
16	Interest on BOI TOD 053027110000021	5628.28
17	Interest on Federal Bank TL A/c	125347.00
18	Interest on HDFC OD A/c 575	17170.11
19	Interest on HDFC STL 310003	30323.84
20	Interest on HDFC TL 001	3384651.65
21	Interest on HDFC TL 003	5238431.63
22	Int on Federal Bank OD 2086	14117.72
23	Int on Federal Bank TL 2A/c 2581	170861.00
24	Int on TL 2698 Federal (35)	1178.30
25	Loan Processing Charges	3760.73
26	Concession grant	79245.50
27	Office Expenses	467,544.56
28	Placement activities	15,158.54
29	Printing and stationery	825,755.92
30	Repairs and maintenance	445,793.80
31	Vehicles diesel	436,332.40
32	Sports and other activities	105,708.52
33	Fees write off	102,300.00
34	Staff training and welfare	97,377.00
35	Students Activities & Welfare	720,990.80
36	Telephone and internet charges	1,030,673.00
37	Travelling expenses	259,319.76
<b>TOTAL RS.</b>		<b>88,353,041.10</b>



# IndiaFIRST™ ROBOTICS Academy

This is to certify that

*Shubhangi V. Gaikar*

has successfully completed Training Program for

*10 days (60 hrs.)* on *Arduino Development*

with Grade *A+*

We want him/her the very best for their future career in  
Engineering and Technology!

Date *15<sup>th</sup> May 2017*

Location *Aundh, Pune*

Certificate No. *20171403*

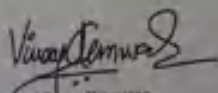
  
Vijay Kumar  
Founder - Chairman

  
www.indiafirstrobotics.com

  
Creating Opportunities, Building Careers  
100 100 2000 Company  
www.habibanimatos.com

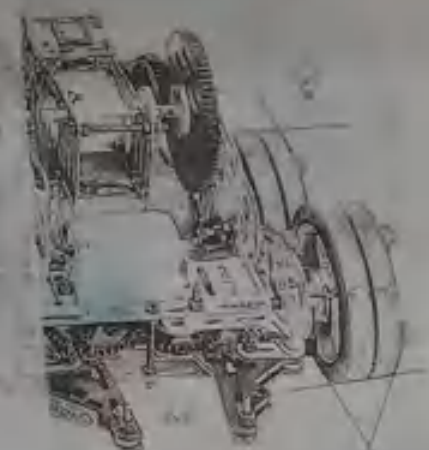

# IndiaFIRST™ ROBOTICS Academy



This is to certify that

*Pallavi S. Mahagaonkar*

has successfully completed Training Program for

*10 days (60 hrs.)* on *Arduino Development*

with Grade *A+*

We wish him/her the very best for their future career in Engineering and Technology!

Date *15<sup>th</sup> May 2017* Location *Aundh, Pune*

Certificate No. *20171401*

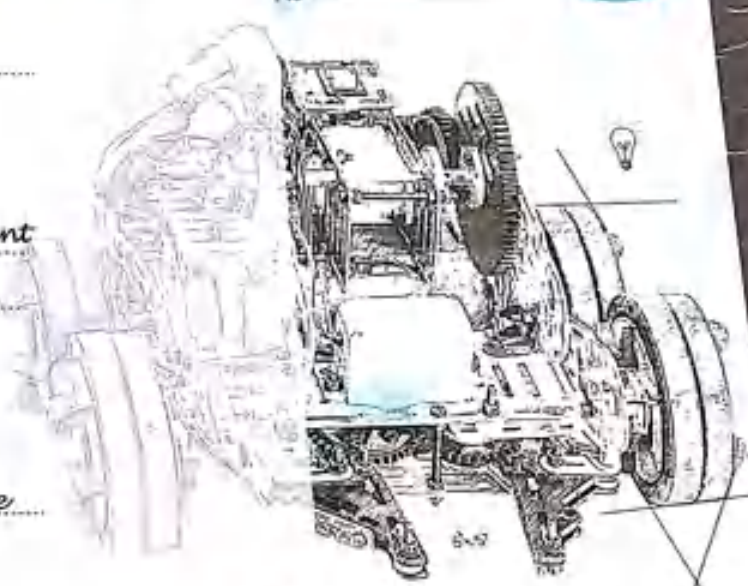

*Vinay Kunwar*  
Vinay Kunwar  
Founder - Chairman

**IndiaFIRST™**  
**ROBOTICS**  
www.indiafirstrobotics.com

**Habib Animatos**  
Creating Opportunities, Building Careers  
ISO 9001:2008 Company  
www.habibanimatos.com





# IndiaFIRST™ ROBOTICS Academy

This is to certify that

*Vandana N. Pagar*

has successfully completed Training Program for

*10 days (60 hrs.)* on *Arduino Development*

with Grade *A+*

We wish him/her the very best for their future career in Engineering and Technology!

Date *15<sup>th</sup> May 2017*

Location *Aundh, Pune*

Certificate No. *20171402*

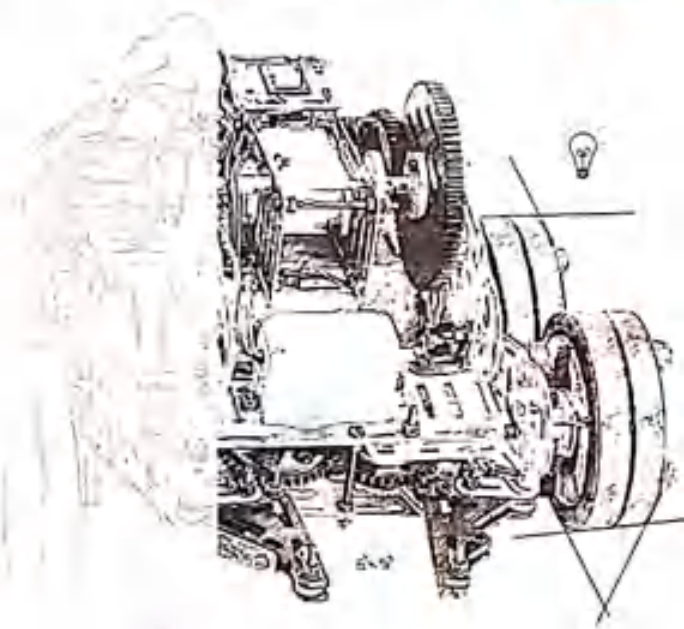

*Vijay Kumar*  
Vijay Kumar  
Founder - Chairman

**IndiaFIRST™**  
**ROBOTICS**  
www.indiafirstrobotics.com

**Habib Animatos**  
Creating Opportunities. Building Careers  
ISO 9001:2008 Certified  
www.habibanimatos.com



# ALL INDIA SHRI SHIVAJI MEMORIAL SOCIETY'S COLLEGE OF ENGINEERING



INTERNATIONAL WORKSHOP

" INFORMATION MANAGEMENT FOR RESEARCH AND EDUCATION ORIENTED LIBRARIES "

18-22 DECEMBER 2017

## CERTIFICATE

This is to certify that Dr/ Prof/Mrs/Mr... Barathe Rahul.....  
of MIT Arts Commerce & Science College, Alandi Participated in  
Pune  
workshop "Information Management for research and education oriented Libraries" from 18-22 December 2017. at

All India Shri Shivaji Memorial Society's College of Engineering, Kennedy Road, Pune-1

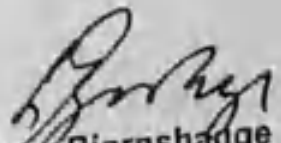
  
Lars Bjornshadje  
Managing Director, DOAJ, Copenhagen

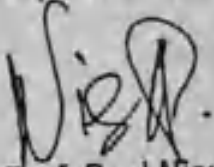
  
Prof. Paul Nieuwenhuysen  
Vrije Universiteit Brussels, Belgium

  
Pieter Lernout  
Universiteit Hasselt, Belgium

  
Dr Egbert De Smet  
Universiteit Antwerpen, Belgium

  
Dr Samir Jalal  
Indian Institute of Technology Kharagpur

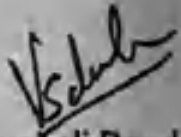
  
Vrushi Dandawate  
Organizing Secretary, AISSMS COE, Pune

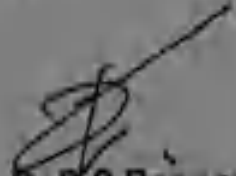
  
Dr D S Bormane  
Principal, AISSMS COE, Pune

# **MIT | Arts, Commerce & Science College**

**Maharashtra Academy of Engineering and  
Educational Research's**

**MIT Arts, Commerce and Science College,**

**Alandi (D) – 412 105.**

**< FINANCIAL SUPPORT FOR TEACHERS TO  
ATTEND CONFERENCE / WORKSHOP >**

**< A.Y. 2018-19 >**

## List of teachers receiving financial support (2018-19)

<b>Sr. No.</b>	<b>Name of teacher</b>	<b>Name of conference/ workshop attended for which financial support provided</b>	<b>Name of the professional body for which membership fee is provided</b>	<b>Amount of support</b>
1	Mrs. Vijayalaxmi M. K.	FDP on Innovative Tools in Teaching	Abeda Inamdar College Pune	1000
2	Mrs. Manjula Chaudhary	FDP on Innovative Tools in Teaching	Abeda Inamdar College Pune	1000
3	Mr. Sarpharajakhtar Tamboli	FDP on Innovative Tools in Teaching	Abeda Inamdar College Pune	1000
4	Mrs. Sushma Chalke	FDP on Innovative Tools in Teaching	Abeda Inamdar College Pune	1000
5	Mrs. Shital Ghotekar	FDP on Innovative Tools in Teaching	Abeda Inamdar College Pune	1000
6	Mrs. Vaishali Kherdekar	FDP on Innovative Tools in Teaching	Abeda Inamdar College Pune	1000
7	Mrs. Sangeeta Borde	Foundation Programme on ICT for Education	IIT Bombay	1000
8	Mr. Mangesh Bhople	Foundation Programme on ICT for Education	IIT Bombay	1000
9	Mrs. Sushma Chalke	Foundation Programme on ICT for Education	IIT Bombay	1000
10	Mr. Bhalchandra Pawar	International Conference on "Sustainable Material for Advanced Research in Technology"	Baburaoji Gholap College, Sangavi, Pune	1500
11	Mrs. Kavita Mahajan	State Level Workshop on Python Programming	Kaveri College of Arts Science & Commerce, Pune	500
12	Mrs. Kavita Mahajan	National Conference on Recent Trends, Issues, Changes and Challeges in Commerce, Management, Economics & Information Technology	Arihant College of Arts, Commerce & Science, Pune	500
13	Mrs. Yashodha Sindhe	National workshop on current research in Mathematics	Department of Mathematics, Central University of Karnataka	1750

**MIT ACSC 18-19**  
**Staff Welfare & Development**  
 Ledger Account

1-Jul-2018 to 31-Mar-2019

51,494.00

Date	Particulars	Vch Type	Vch No	Debit
1-7-2018	By <b>Opening Balance</b>			
26-7-2018	To <b>Cash</b> <i>Being cash payment for registration fees against FDP Dt. 12.05.2018 by Abeda Inamdar college pune as per details attached- Mrs Vijayalaxmi M.K - HOD INNOVATIVE TOOLS IN TEACHING - 7th may 2018 to 12may 2018</i>	Payment	P-149	1,000.00
	To <b>Cash</b> <i>Being cash payment for Registration fees against FDP dt.08.03.2018 to 12.04.2018 by indian Institute of technology Bombay as per details attached. - Mrs Sangeeta Bordo - FOUNDATION PROGRAM IN ICT FOR EDUCATION</i>	Payment	P-150	1,000.00
	To <b>Cash</b> <i>Being cash payment for Registration fees against FDP dt.07.05.2018 to 12.05.2018 by Abeda Inamdar college as per details attached - Manjula C - INNOVATIVE TOOLS IN TEACHING</i>	Payment	P-151	1,000.00
	To <b>Cash</b> <i>Being cash payment for Registration fees against FDP dt.07.05.2018 to 12.05.2018 by Abeda Inamdar college as per details attached - Tamboli Sarpharajaktar - INNOVATIVE TOOLS IN TEACHING</i>	Payment	P-152	1,000.00
	To <b>Cash</b> <i>Being cash payment for Registration fees against FDP dt.08.03.2018 to 12.04.2018 by indian Institute of technology Bombay as per details attached. - Mrs Sushma chalke - FOUNDATION PROGRAM IN ICT FOR EDUCATION</i>	Payment	P-153	1,000.00
	To <b>Cash</b> <i>Being cash payment for Registration fees against FDP dt.07.05.2018 to 12.05.2018 by Abeda Inamdar college as per details attached - Vaishali Kherdekar - INNOVATIVE TOOLS IN TEACHING</i>	Payment	P-154	1,000.00
	To <b>Cash</b> <i>Being cash payment for Registration fees against FDP dt.07.05.2018 to 12.05.2018 by Abeda Inamdar college as per details attached - Shital ghotekar - INNOVATIVE TOOLS IN TEACHING</i>	Payment	P-155	1,000.00

Carried Over

7,000.00

51,494.00



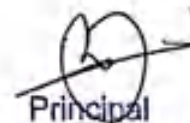

**Principal**  
 MIT Arts, Commerce & Science College  
 Alandi, Pune - 412 105.

continued ...

## MIT ACSC 18-19

Staff Welfare &amp; Development Ledger Account : 1-Jul-2018 to 31-Mar-2019

Page 2

Date	Particulars	Vch Type	Vch No.	Debit	Credit
	Brought Forward			7,000.00	51,494.00
26-7-2018	To Cash Being cash payment for Registration fees against FDP dt.07.05.2018 to 12.05.2018 by Abeda Inamdar college as per details attached - Sushma chalke - INNOVATIVE TOOLS IN TEACHING	Payment	P-156	1,000.00	
27-7-2018	To Cash Being cash payment for Registration fees against FDP dt.08.03.2018 to 12.04.2018 by Indian Institute of Technology Bombay as per details attached. - Mangesh Bhople - FOUNDATION PROGRAM IN ICT FOR EDUCATION	Payment	P-159	1,000.00	
16-8-2018	To Cash Being reimbursement of expenses on travelling charges and break fast for a regional workshop at Mumbai as per details attached - Shriram Sir.	Payment	P-179	2,450.00	
27-12-2018	To Cash Being cash payment for Registration fees against Workshop Dt.12.10.18 organize by Dr.D.Y.Patil Institute of Engineering and Technology as per details attached - Mr Nilesh Mate	Payment	P-371	400.00	
14-2-2019	To Cash Being cash payment for registration fees against Workshop Dt.27.11.18 organize by IMCC institute as per details attached. - Sunita Sabale	Payment	P-426	400.00	
18-3-2019	To Cash Being cash payment for Registration fees against Workshop Dt.09.02.19 organize by sofftech solutions Pune as per details attached. -Mrs.Sarika Padwal	Payment	P-458	1,700.00	
	To Cash Being cash payment for Registration fees against Conference dt.05.02.19 organize by Baburaoji Gholap college as per details attached. - Mr.B.B.Pawar	Payment	P-459	1,500.00	
	To Closing Balance			15,450.00	51,494.00
				36,044.00	
				51,494.00	51,494.00



Principal  
MIT Arts, Commerce & Science College  
Alandi, Pune - 412 105.

**MIT ACSC 19-20**  
**Staff Welfare & Development**  
 Ledger Account

1-Apr-2019 to 30-Apr-2019

Page 1  
 Credit

Date	Particulars	Vch Type	Vch No.	Debit	Credit
15-4-2019	To Cash	Payment	P-22	500.00	
	To Cash	Payment	P-21	500.00	
17-4-2019	To Cash	Payment	P-26	1,750.00	
				2,750.00	
By	Closing Balance				2,750.00
				2,750.00	2,750.00

*[Handwritten signature]*

  
**Principal**  
 MIT Arts, Commerce & Science College  
 Alandi, Pune - 412 105.

# Audit Statements for F.Y. - 2018-19.

## SCHEDULE NO. 10

### EXPENDITURE ON OBJECT OF TRUST

SR. NO.	PARTICULARS	AMOUNT RS.
1	Campus Exp	710,971.02
2	Consumable Goods	454,534.40
3	Electricity Charges	2,736,923.00
4	Housekeeping & Security Charges	10,513,479.96
5	Interest on OD/TL/STL	4,950,910.22
6	Office Exp.	510,565.79
7	Printing & Stationery Exp	571,634.63
8	Salary	
	PF Employer Contribution	2,619,397.00
	Salary - Non Teaching	19,859,626.00
	Salary - Teaching	47,336,716.00
9	Student Activities	842,145.06
10	Telephone / Mobile Bills & Internet Charges	815,245.88
11	Travelling & Conveance Expenses	1,175,985.04
12	University Exp	897,527.00
13	Vehicle Diesel & Maintenance Charges	549,932.00
14	Visiting/ Honorarium/ Professional Fees	1,772,521.74
15	Advertising Marketing Expenses	4,820,270.44
16	Write Off Fees	544,800.00
17	Audit Fees	25,000.00
18	Cheque Return Charges	27,435.00
19	Gratuity 1819	403,923.00
20	Industrial Visits	11,970.00
21	Library Expenses	30,799.84
22	Placement Expenses	11,767.76
23	Printing & Stationery	432,065.28
24	Property Tax	315,782.00
25	Repair & Maintenance	496,482.34
26	Seminars & Conference	28,028.00
27	Sports Activities	62,534.86
28	Staff Welfare & Development	147,474.42
<b>TOTAL RS.</b>		<b>103,676,447.68</b>







M.C.E. Society's

**ABEDA INAMDAR SENIOR COLLEGE  
OF ARTS, SCIENCE AND COMMECRE, CAMP, PUNE**



Sponsored By  
**Savitribai Phule Pune University**

*Certificate*

Awarded to Mr./Ms./Dr. VijayaLaxmi M.K. from MIT Art's , Commerce  
& sci college, Alandi for Participation in the State level Six Days Faculty Development Program on the topic  
"INNOVATIVE TOOLS IN TEACHING" from 7<sup>th</sup> May 2018 to 12<sup>th</sup> May 2018 at the Abeda Inamdar Senior College of Arts,  
Science And Commerce ,Azam Campus, Camp, Pune-01.

Dr. Shaila Bootwala,  
Principal



Prof. Salauddin Sajjan  
Coordinator



M.C.E. Society's

**ABEDA INAMDAR SENIOR COLLEGE  
OF ARTS, SCIENCE AND COMMECRE, CAMP, PUNE**



Sponsored By  
**Savitribai Phule Pune University**

*Certificate*

Awarded to Mr./Ms./Dr. Manjula Pramod Chaudhary from MIT Art's , commerce & sci college , Alandi for Participation in the State level Six Days Faculty Development Program on the topic "INNOVATIVE TOOLS IN TEACHING" from 7<sup>th</sup> May 2018 to 12<sup>th</sup> May 2018 at the Abeda Inamdar Senior College of Arts, Science And Commerce ,Azam Campus, Camp, Pune-01.

Dr. Shaila Bootwala  
Principal



Prof. Salauddin Sajjan  
Coordinator



M.C.E. Society's

**ABEDA INAMDAR SENIOR COLLEGE  
OF ARTS, SCIENCE AND COMMECRE, CAMP, PUNE**



Sponsored By  
**Savitribai Phule Pune University**

*Certificate*

Awarded to Mr./Ms./Dr. Parpharajakhtar Tamboli from MIT Art's, Commerce & Science College, Alandi for Participation in the State level Six Days Faculty Development Program on the topic "INNOVATIVE TOOLS IN TEACHING" from 7<sup>th</sup> May 2018 to 12<sup>th</sup> May 2018 at the Abeda Inamdar Senior College of Arts, Science And Commerce ,Azam Campus, Camp, Pune-01.

Dr. Shaila Boetwala .  
Principal



Prof. Salauddin Sajjan  
Coordinator



M.C.E. Society's

**ABEDA INAMDAR SENIOR COLLEGE  
OF ARTS, SCIENCE AND COMMECRE, CAMP, PUNE**



Sponsored By  
**Savitribai Phule Pune University**

*Certificate*

Awarded to Mr./Ms./Dr. Sushma Pradeep Chalke from MIT Art's, Commerce & Sci college, Alandi for Participation in the State level Six Days Faculty Development Program on the topic "INNOVATIVE TOOLS IN TEACHING" from 7<sup>th</sup> May 2018 to 12<sup>th</sup> May 2018 at the Abeda Inamdar Senior College of Arts, Science And Commerce ,Azam Campus, Camp, Pune-01.

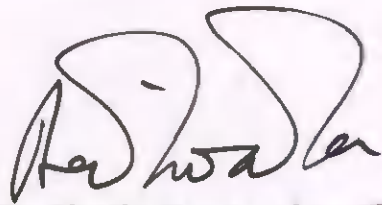
  
Dr. Shaila Bootwala  
Principal



  
Prof. Salauddin Sajjan  
Coordinator



M.C.E. Society's

**ABEDA INAMDAR SENIOR COLLEGE  
OF ARTS, SCIENCE AND COMMECRE, CAMP, PUNE**



Sponsored By  
**Savitribai Phule Pune University**

*Certificate*

Awarded to Mr./Ms./Dr. Shital Vaibhav Ghotekar from MIT Art's, Commerce & Sci college, Alandi for Participation in the State level Six Days Faculty Development Program on the topic "INNOVATIVE TOOLS IN TEACHING" from 7<sup>th</sup> May 2018 to 12<sup>th</sup> May 2018 at the Abeda Inamdar Senior College of Arts, Science And Commerce ,Azam Campus, Camp, Pune-01.

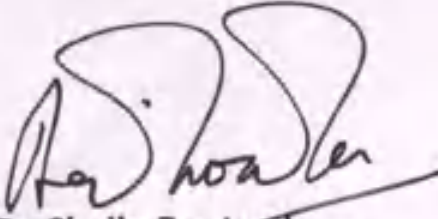
  
Dr. Shaila Bootwala  
Principal -

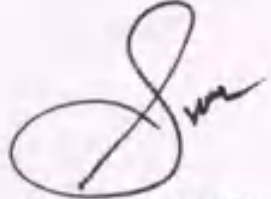

  
Prof. Salauddin Sajjan  
Coordinator



M.C.E. Society's

**ABEDA INAMDAR SENIOR COLLEGE  
OF ARTS, SCIENCE AND COMMECRE, CAMP, PUNE**



Sponsored By  
**Savitribai Phule Pune University**

*Certificate*

Awarded to Mr./Ms./Dr. Vaishali A. Kherdekar from MIT Arts, Commerce & Sci college, Alandi for Participation in the State level Six Days Faculty Development Program on the topic "INNOVATIVE TOOLS IN TEACHING" from 7<sup>th</sup> May 2018 to 12<sup>th</sup> May 2018 at the Abeda Inamdar Senior College of Arts, Science And Commerce ,Azam Campus, Camp, Pune-01.

**Dr. Shaila Bootwala**  
Principal



**Prof. Salauddin Sajjan**  
Coordinator



## Certificate

This is to certify that

**Sangeeta Borde**

from Remote Center ID 1407

successfully completed an AICTE approved Faculty Development Programme (FDP101x) on

**Foundation Program in ICT for Education**

conducted by Indian Institute of Technology Bombay

from March 8, 2018 to April 12, 2018

*(Online activity from Thursday 08 March 2018 to Thursday 12 April 2018 and  
Physical participation at Remote Center on 24 and 25 March 2018, together considered as two-week equivalent FDP course)*

This FDP was held under the aegis of Pandit Madan Mohan Malaviya National Mission for Teachers and Teaching (PMMMNMTT), MHRD, Govt. of India

**Prof. Deepak B. Phatak**

Project and Course Coordinator  
IIT Bombay



# Certificate

This is to certify that

**Mangesh Bhople**

from Remote Center ID 1407

successfully completed an AICTE approved Faculty Development Programme (FDP101x) on

**Foundation Program in ICT for Education**

conducted by Indian Institute of Technology Bombay

from March 8, 2018 to April 12, 2018

*(Online activity from Thursday 08 March 2018 to Thursday 12 April 2018 and  
Physical participation at Remote Center on 24 and 25 March 2018, together considered as two-week equivalent FDP course)*

This FDP was held under the aegis of Pandit Madan Mohan Malaviya National Mission for Teachers and Teaching (PMMMNMTT), MHRD, Govt. of India

**Prof. Deepak B. Phatak**  
Project and Course Coordinator  
IIT Bombay





# Certificate

This is to certify that

**Sushma Chalke**

from Remote Center ID 1063

successfully completed an **AICTE approved** Faculty Development Programme (FDP101x) on

## Foundation Program in ICT for Education

conducted by Indian Institute of Technology Bombay

from March 8, 2018 to April 12, 2018

*(Online activity from Thursday 08 March 2018 to Thursday 12 April 2018 and  
Physical participation at Remote Center on 24 and 25 March 2018, together considered as two-week equivalent FDP course)*

This FDP was held under the aegis of Pandit Madan Mohan Malaviya National Mission for Teachers and Teaching (PMMMNMTT), MHRD, GoI

**Prof. Deepak B. Phatak**

Project and Course Coordinator

IIT Bombay



SMART-2019

Pune District Education Association's

**Baburaoji Gholap College,**

Sangvi, Pune - 411 027. India

International Conference on "Sustainable Materials for Advanced Research in Technology" (SMART-2019)

Sponsored by Savitribai Phule Pune University (SPPU)

*Certificate*

This is to certify that Prof./Dr./Mr./Ms. Balchandra B. Pawar of  
MIT, Art, commerce, science college, Alandi has attended/ presented a poster/  
oral research paper entitled SMART charger ..... with temperature Monitoring  
in the International Conference on "Sustainable Materials for Advanced Research in Technology" (SMART-  
2019) organized at B. G. College, Sangvi, Pune-411027 on 5<sup>th</sup> & 6<sup>th</sup> February 2019

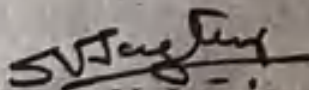
  
Dr. Sangeeta V. Jagtap  
Coordinator

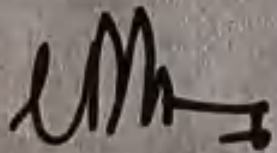
  
Dr. Shivaji K. Dhage  
Vice Principal

  
Dr. Latesh K. Nikam  
Vice Principal

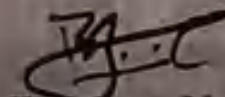
  
Dr. Balkrishan N. Zaware  
Principal

# Certificate

## Two Days State Level Workshop On Python Programming

29<sup>th</sup> & 30<sup>th</sup> January, 2019

This is to certify that Mr./Ms./Dr. Kavilā Dattu Mahajan of

MIT Arts, Science & Commerce College has actively participated

in the Two Days State Level Workshop on 'Python Programming' under **Quality Improvement Programme (QIP)** of  
**Savitribai Phule Pune University, Pune**



**Mr. Kushal Hegde**  
President, Kannada Sangha Pune

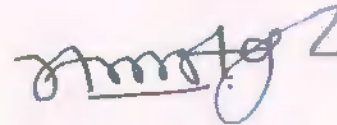

**Dr. Ashok Agrawal**  
Principal & Convenor

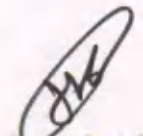

**Dr. Jayashri Bangali**  
Coordinator



Arihant Education Foundation's  
**Arihant College of Arts, Commerce  
& Science, Camp, Pune - 01**

Phone: 020-67240900 Web: www.arihant.education



## **Accolade 2019**

**National Level Conference**

on

**"RECENT TRENDS, ISSUES, CHANGES AND CHALLENGES IN COMMERCE,  
MANAGEMENT, ECONOMICS AND INFORMATION TECHNOLOGY"**

This is to certify that

Dr. / Prof. / Mr. / Mrs. / Miss Kavita Mahajan

From MIT Arts Commerce And Science College, Standi (D)

was a Resource Person / has participated / presented / published a paper titled

Apache Quiz

in the National Level Conference jointly organized by Savitribai Phule Pune University and  
Arihant College of Arts, Commerce & Science, Camp, Pune on 1<sup>st</sup> and 2<sup>nd</sup> Feb 2019.

Chetan Parikh  
Campus Director,  
ACACS, Camp, Pune

Priti Kedari  
Conference Coordinator

Principal ACACS,  
Camp, Pune





*This is to certify that*

YASHODHA SANJAY SINDHE

*from*

MIT ARTS COMMERCE AND SCIENCE COLLEGE ALANDI PUNE

*participated in the*

*National Workshop on Current Research in Mathematical Sciences held at  
Department of Mathematics, Central University of Karnataka  
from 28-30 March 2019.*

Dr. G. Jonardhana Reddy  
Organizing Secretary & Convener

Prof. G. R. Naik  
Pro-Vice Chancellor